

# CORMACH

16600 E  
18000 E A.S.C.

ANNO - YEAR - ANS  
45°  
- ANNO - JHAR - ANS







# 16600 E

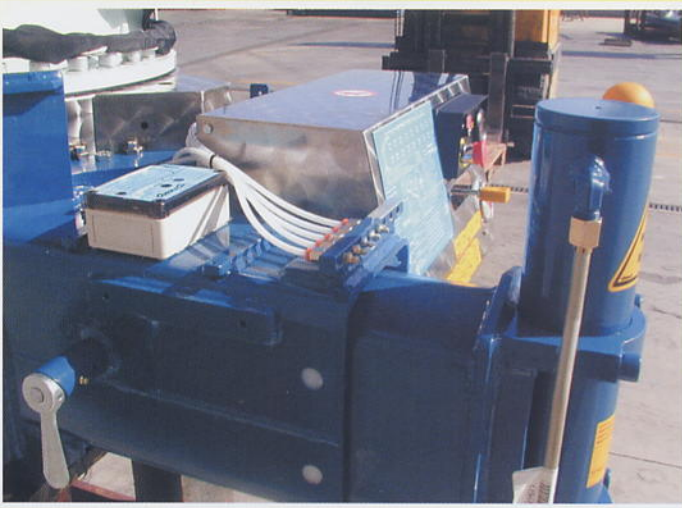

- Ingrassatore centralizzato - Timer Reset.
- Centralised greasing system - Timer Reset.
- Graissage centralisé - Timer Reset.
- Zentral schmieranlage - Timer Reset.
- Engrasado centralizado - Timer Reset.

- Posto di manovra in acciaio inox comprendente bolla di stabilizzazione, manometro, diagramma portata, conta-ore, pulsante di emergenza, clacson e simboli di leve in materiale termoidurente.
- Control place in stainless steel including stabilising level gauge, pressure gauge, lifting chart, hourmeter, emergency push button, horn and lever symbols in plastic material.
- Poste de commande en acier inox comprenant bulle de stabilisation, manometre, table de capacité, compte-heures, bouton d'urgence, klacson et symboles de leviers en matériel thermodurcissable.
- Arbeits in rostfreier stahl mit, glizerin dosennivelle, manometer, last diagramme, not knopf, hupe, hebeln symbolen in kunststoff.
- Puesto de mando de acero inox incluye burbuja de estabilización, manometro, diagrama de las capacidades de la grúa, cuenta-horas, pulsador de emergencia, clacson y símbolos de palancas de material endurecido al calor.

# GOMAG



# SERIE 16600 E

- Boccole in materiale autolubrificante.
- Bushes made in selflubricating material.
- Bagues en matériel auto-lubrifiant.
- Büchsen aus selbstschmierenden Material.
- Los casquillos están fabricados con material autolubrificante.

- Perni in acciaio speciale.
- Pins in special steel.
- Pivots en acier spécial.
- Bolzen aus spezialstahl.
- Pernos en aceri especial.

- Torretta con spallamenti allargati; l'ottima rigidità a torsione delle torrette delle gru Cormach è stato ulteriormente migliorato allargando le "spalle" della torretta.
- Twist mast larger; the optimum torsion rigidity of the twist masts of the cranes Cormach had been too bettered enlarging the "shoulders" of twist mast.
- Tourelle avec montants plus larges; l'optimum rigidité de torsion des tourelles des grues Cormach a été améliorée en élargissant les "montants" de la tourelle.
- Turm mit erweiterten Schultern; der optimale Torsionswiderstand des Kranturms Cormac ist durch die Erweiterung der Turm-"Schulter" weiter verbessert worden.
- Torreta con lomos más anchos; la optima rigidez a la torsión de las torretas de las grúas Cormach ha sido ulteriormente mejorada anchando las "espaldas" de la torreta.

- Braccio telescopico a sezione esagonale. Massima resistenza.
- Telescopic boom with hexagonal section. Greater resistance.
- Bras télescopique avec section hexagonale pour obtenir plus résistance.
- Höchste stabilität durch sechskantprofile am ausschub.
- Branzo telescópico con sección hexagonal para una mayor resistencia.

- Corsa dei telescopici extralunga per uno sbraccio massimo idraulico di 12,23 m (versione 16600 E4).
- Extra-long telescopic stroke for a maximum hydraulic extension of 12,23 m (version 16600 E4).
- Extension des télescopiques extra-long pour une extension hydraulique maximum de 12,23 m (version 16600 E4).
- Extralanger Hub der Teleskoparme mit einer maximalen hydraulischen Streckung von 12,23 m (Version 16600 E4).
- Extensión de los telescópicos extra-larga para una apertura máxima hidráulica de 12,23 m (versión 16600 E4).

- Cuscinetto di base a rulli, massima resistenza, precisione di movimento, minimo attrito, nessuna usura.
- Highly resistant base roller bearing, outstanding motion precision, very little friction, no wear.
- Couronne à rouleaux pour obtenir résistance maximume, précision de mouvement, minimume friction et pas d'usure.
- Der schrägrollengelagerte Drehkranz ermöglicht feinfühligere bewegungsabläufe, erzeugt niedrige reibung und ist äusserst verschleissfest.
- Rodamientos de base en rodillos, máxima resistencia, precisión de movimientos y minima fricción: ningún desgaste.

- Carter ralla in acciaio inox.
- Slew bearing protection in stainless steel.
- Protection couronne en acier inox.
- Drehkranz schutz in rostfreier stahl.
- Proteccion de la corona en acero inoxidable.

- Braccio sagomato con sezione chiusa, massima resistenza a torsione e massima leggerezza della struttura.
- Shaped arm with closed section, max. resistance to torsional stress, and light structure.
- Bras façonné à coupe fermée permettant d'obtenir haute résistance à la torsion et structure très légère.
- Durch die geschlossene konstruktion des hubarmes, wird eine hohe verdrehsteifigkeit bei geringem eigengewicht erreicht.
- El perfil del brazo ed de sección cerrada para alcanzar la máxima resistencia en los eufuerzos de torsión, con una estructura ligera.

- Massima potenza, n. 2 cilindri di sollevamento per maggior resistenza.
- Outstanding power, 2 lifting cylinders granting higher resistance.
- Puissance maximume, nr.2 verins de levage pour obtenir plus résistance.
- 2 haupthubzylinder erzeugen eine gleichmässige hubkraft und garantieren eine hohe betriebssicherheit.
- Maxima potencia, n° 2 cilindros para levantar y para mayor resistencia.

- Rotazione con motore riduttore: potenza, affidabilità, sensibilità al comando. Freno idraulico (a richiesta rotazione continua).
- Rotation with engine and reduction gear, power, reliability, remarkable drive sensibility. Hydraulic brake (option off continuous rotation).
- Rotation par moto-réducteur avec frein hydraulique, puissance, fiabilité, sensibilité aux commandes. (Rotation continue sur demande).
- Schwenkwerk angetrieben durch einen Hydraulikmotor mit untersetzungsgetriebe; betriebssicherheit durch hydraulische bremsen; feinfühligere bewegungen beim schwenken des kranes (endlosdrehung auf wunsch).
- Rotación con motor y reductor: potencia, fiabilidad y sensibilidad al mando. Freno hidráulico. (Opción: rotación continua).

- Valvola flangiata sui cilindri per maggior sicurezza.
- Flanged valve on the cylinder for greater safety.
- Soupape de sûreté flasquée sur les verins pour obtenir plus sécurité.
- Direkt gefflanschte ventile für ihre sicherheit.
- Válvula antirretorno para mayor seguridad.

- Stabilizzatori extralarghi con cilindri di estensione protetti.
- Wide outriggers extension with protected cylinders.
- Stabilisateur avec grande extension et verins protégés.
- Grosse abstützbreite mit abgedekten abstützzyllindern.
- Estabilizadores super-anchos martinetes de extension protegidos.

- Attacco al telaio oscillante in conformita' alle specifiche dei maggiori costruttori di veicoli industriali
- 3 point linkage as required by the leading truck manufactures.
- Atelage à trois points en conformité aux prescriptions des principaux constructeurs de véhicules industriels.
- 3 punkt torsiionsbrücke nach den aufbaubaurichtlinien der führenden LKW hersteller.
- Enganche al bastidor oscilante según recomiendan los principales constructores de vehiculos industriales.





# 16600 E



- Serbatoio olio in acciaio inox e tubature rigide sul 1° braccio.
- Oil tank in stainless steel and steel pipes on 1st boom.
- Reservoir d'huile en acier inox et tube rigides sur 1ere bras.
- Oel tank in rostfreier stahl und stahl rhöre am ersten arm.
- Deposito aceite en acero inoxidable y tuberías rígidas en primer brazo.





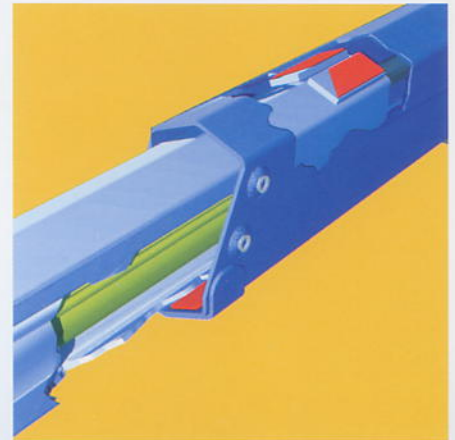
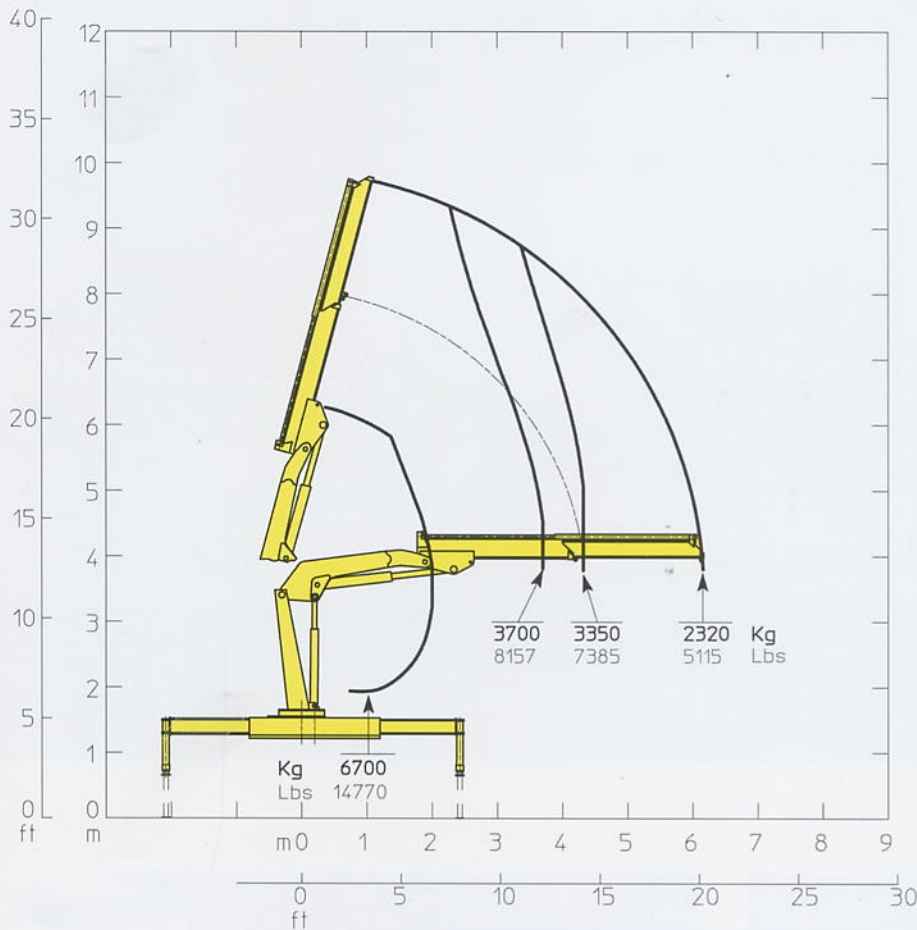

### STANDARD

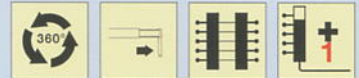

### OPTIONAL

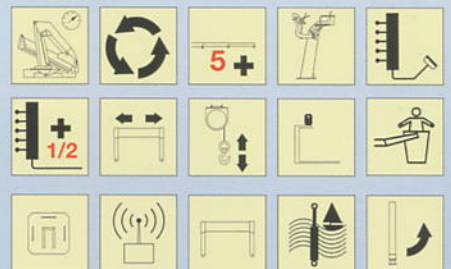

PROLUNGHE MANUALI    MANUAL EXTENSIONS    RALLONGES MANUELLES    MANUELLE VERLAENGERUNGEN    PROLONGAS MECANICAS

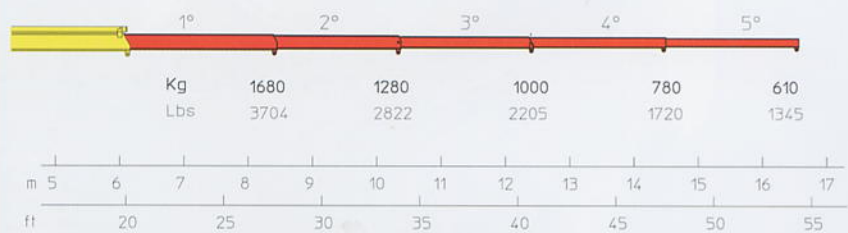

	E1	E1
Momento statico massimo al perno torretta - Max. static moment at the turret pin - Moment statique max. à l'axe de la tourelle - Max. statisches Hubmoment am Kransaulenbolzen	16600 daN • m	120090 lbs • ft
Sbraccio idraulico - Hyd. boom length - Longueur du bras Hyd. - Hyd. Reichweite	6,18 m	20'3"
Sbraccio con prolunghe manuali - Boom length with manual extensions - Longueur du bras avec rallonges manuelles - Auslegerlänge - Longitud del brazo hidráulico con prolongas manuales	16,50	54'2"
Coppia di rotazione - Slew torque - Moment de rotation - Drehmoment	1750 daN • m	12660 lbs • ft
Tempo di rotazione - Slewing speed - Temp de rotation - Schwenkgeschwindigkeit	24 sec - 360°	24 sec - 360°
Uscita stabilizzatori - Outriggers extension - Sortie des bequilles - Breite der Abstützung	1610+1350 mm	5'3"+4'5"
Larghezza stabilizzatori - Outriggers width - Largeur des bequilles - Gesamtbreite der Abstützung	5325 mm	17'6"
Lunghezza - Outriggers - Largeur - Gesamtbreite - Ancho	790 mm	27"
Larghezza - Width - Largeur - Breite	2478 mm	8'2"
Altezza - Height - Hauteur - Höhe	2309 mm	7'7"
Peso (senza olio e montaggio) - Weight (without oil and fitting) - Poids (sans huile et montage) - Gewicht (ohne Öl und ohne)	1880 Kg	4145 lbs
Portata pompa - Pump delivery - Capacité de la pompe - Pumpenleistung	35 lit / min	9 us gal / min
Pressione - Pressure - Pression - Druck	270 bar	3839 psi
Capacità serbatoio olio - Oil tank capacity - Capacité du réservoir d'huile - Öl tank inhalt - Aceite	120 lit	32 us gal

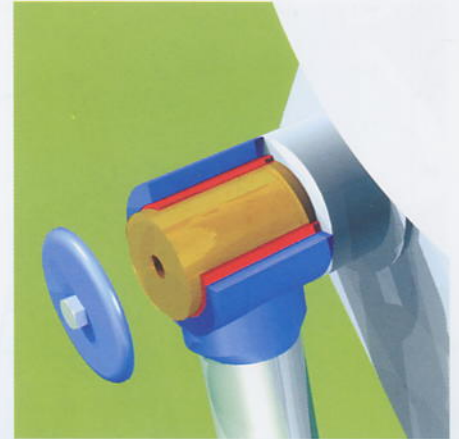
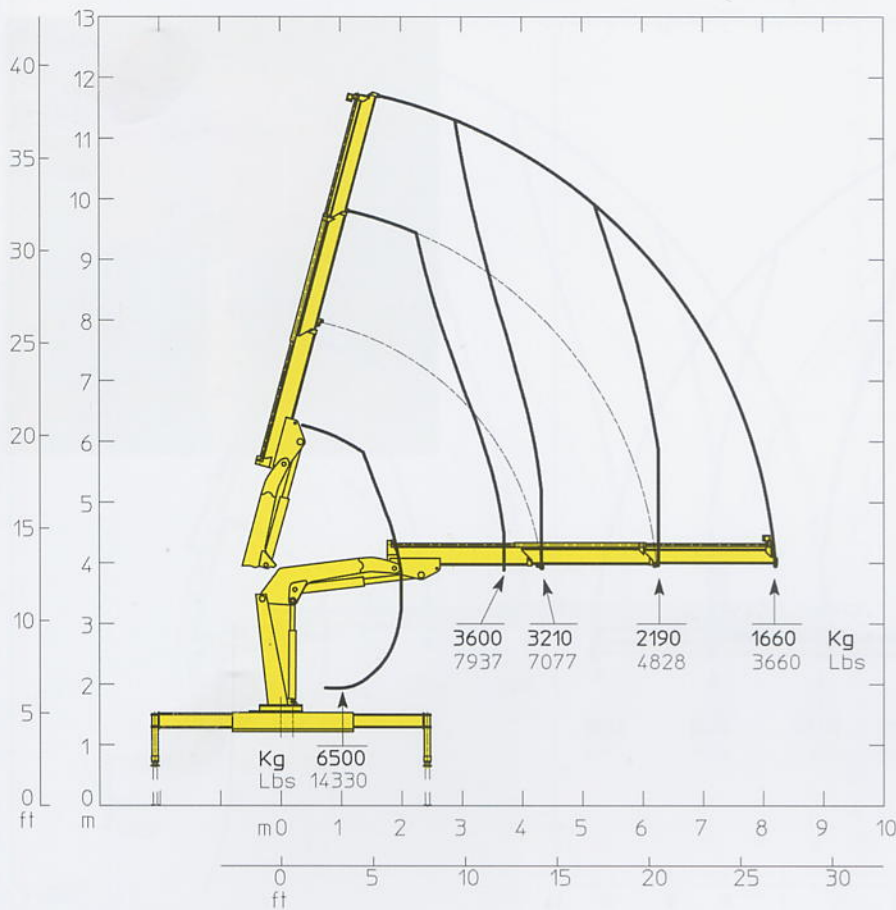

PROLUNGHE MANUALI      MANUAL EXTENSIONS      RALLONGES MANUELLES      MANUELLE VERLÄNGERUNGEN      PROLONGAS MECANICAS

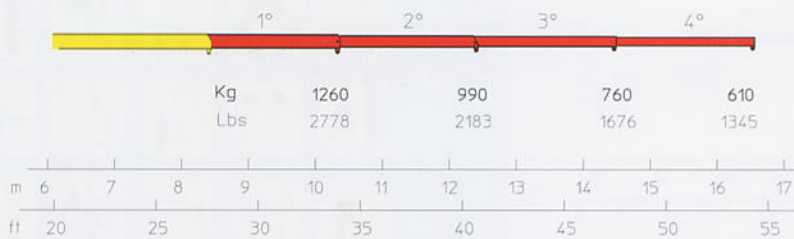

## STANDARD

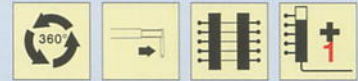

## OPTIONAL

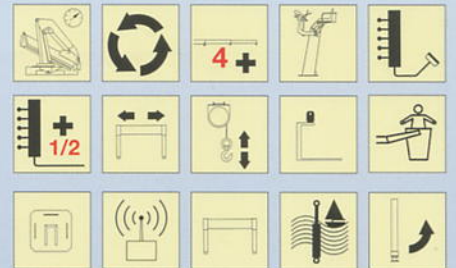

	E2	E2
Momento statico massimo al perno torretta - Max. static moment at the turret pin - Moment statique max. à l'axe de la tourelle - Max. statisches Hubmoment am Kransaulenbolzen	16600+ daN • m	120090 lbs • ft
Sbraccio idraulico - Hyd. boom length - Longueur du bras Hyd. - Hyd. Reichweite	8,23 m	27'00"
Sbraccio con prolunghe manuali - Boom length with manual extensions - Longueur du bras avec rallonges manuelles - Auslegerlänge - Longitud del brazo hidráulico con prolongas manuales	16,47 m	54' 00"
Coppia di rotazione - Slew torque - Moment de rotation - Drehmoment	1750 daN • m	12660 lbs • ft
Tempo di rotazione - Slewing speed - Temp de rotation - Schwenkgeschwindigkeit	24 sec - 360°	24 sec - 360°
Uscita stabilizzatori - Outriggers extension - Sortie des bequilles - Breite der Abstützung	1610+1350 mm	5'3"+4'5"
Larghezza stabilizzatori - Outriggers width - Largeur des bequilles - Gesamtbreite der Abstützung	5325 mm	17'6"
Lunghezza - Outriggers - Largeur - Gesamtbreite - Ancho	790 mm	27"
Larghezza - Width - Largeur - Breite	2478 mm	8'2"
Altezza - Height - Hauteur - Höhe	2309 mm	7'7"
Peso (senza olio e montaggio) - Weight (without oil and fitting) - Poids (sans huile et montage) - Gewicht (ohne Öl und ohne)	2000 Kg	4409 Lbs
Portata pompa - Pump delivery - Capacité de la pompe - Pumpenleistung	35 lit /min	9 us gal/min
Pressione - Pressure - Pression - Druck	270 bar	3839 psi
Capacità serbatoio olio - Oil tank capacity - Capacité du réservoir d'huile - Öl tank inhalt - Aceite	120 lt	32 us gal



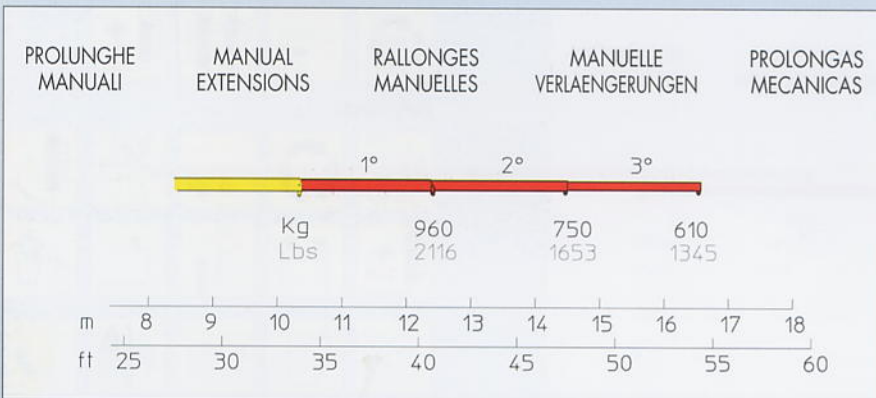
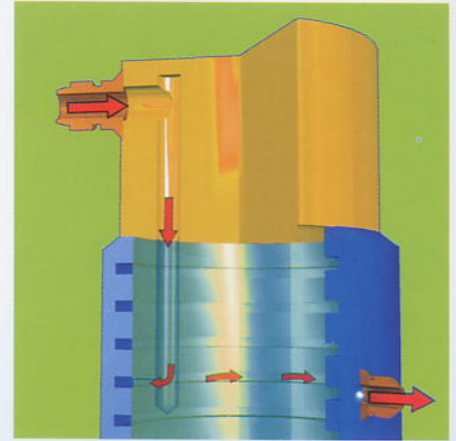
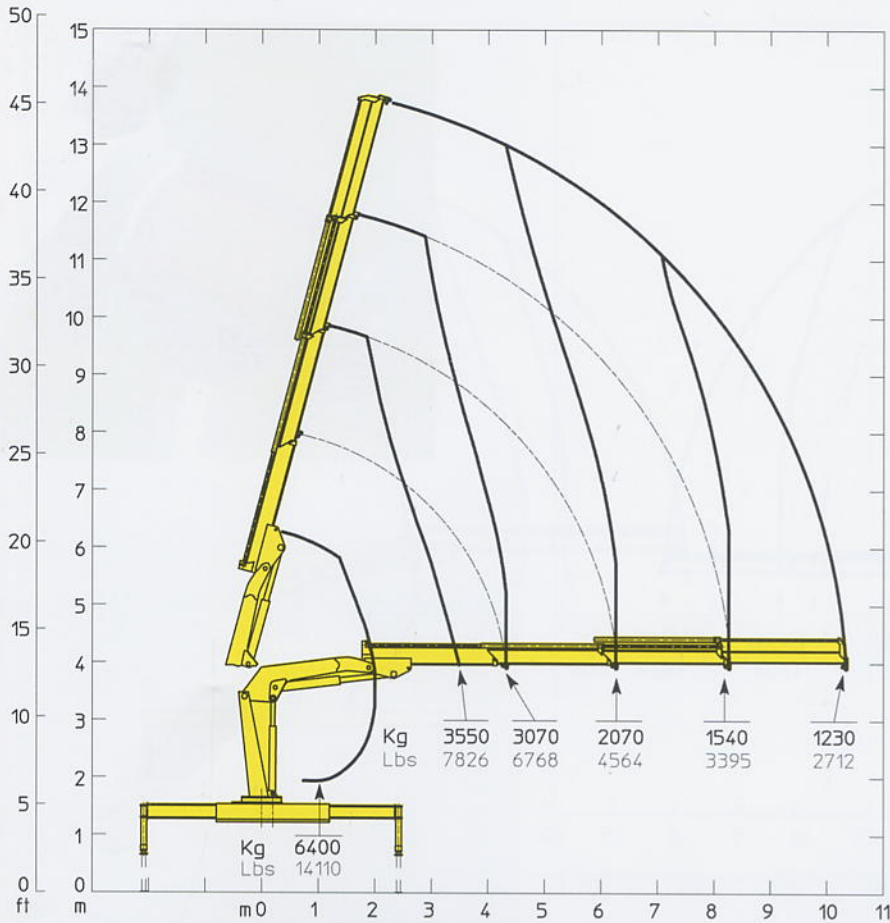

### STANDARD



### OPTIONAL

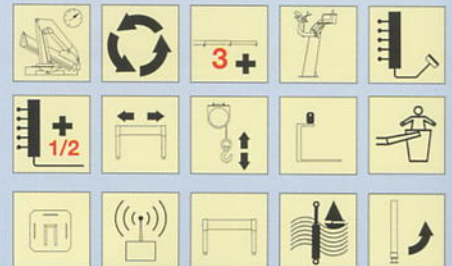

	E3	E3
Momento statico massimo al perno torretta - Max. static moment at the turret pin - Moment statique max. à l'axe de la tourelle - Max. statisches Hubmoment am Kransaulenbolzen	16600 daN • m	120090 lbs • ft
Sbraccio idraulico - Hyd. boom length - Longueur du bras Hyd. - Hyd. Reichweite	10,27 m	33'8"
Sbraccio con prolunghe manuali - Boom length with manual extensions - Longueur du bras avec rallonges manuelles - Auslegerlänge - Longitud del brazo hidráulico con prolongas manuales	16,47	54' 00"
Coppia di rotazione - Slew torque - Moment de rotation - Drehmoment	1750 daN • m	12660 lbs • ft
Tempo di rotazione - Slewing speed - Temp de rotation - Schwenkgeschwindigkeit	24 sec - 360°	24 sec - 360°
Uscita stabilizzatori - Outriggers extension - Sortie des bequilles - Breite der Abstützung	1610+1350 mm	5'3"+4'5"
Larghezza stabilizzatori - Outriggers width - Largeur des bequilles - Gesamtbreite der Abstützung	5325 mm	17'6"
Lunghezza - Outriggers - Largeur - Gesamtbreite - Ancho	790 mm	27"
Larghezza - Width - Largeur - Breite	2478 mm	8'2"
Altezza - Height - Hauteur - Höhe	2309 mm	7'7"
Peso (senza olio e montaggio) - Weight (without oil and fitting) - Poids (sans huile et montage) - Gewicht (ohne Öl und ohne)	2150 Kg	4740 Lbs
Portata pompa - Pump delivery - Capacité de la pompe - Pumpenleistung	35 lit /min	9 us gal/min
Pressione - Pressure - Pression - Druck	270 bar	3839 psi
Capacità serbatoio olio - Oil tank capacity - Capacité du réservoir d'huile - Öl tank inhalt - Aceite	120 lit	32 us gal

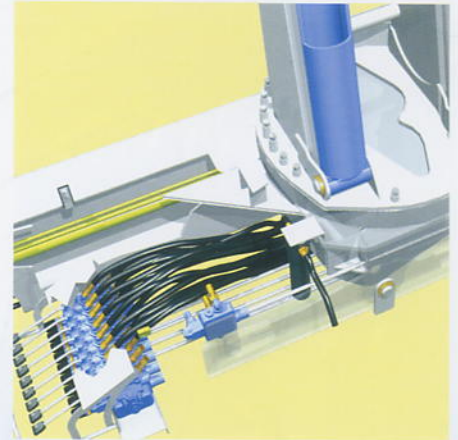
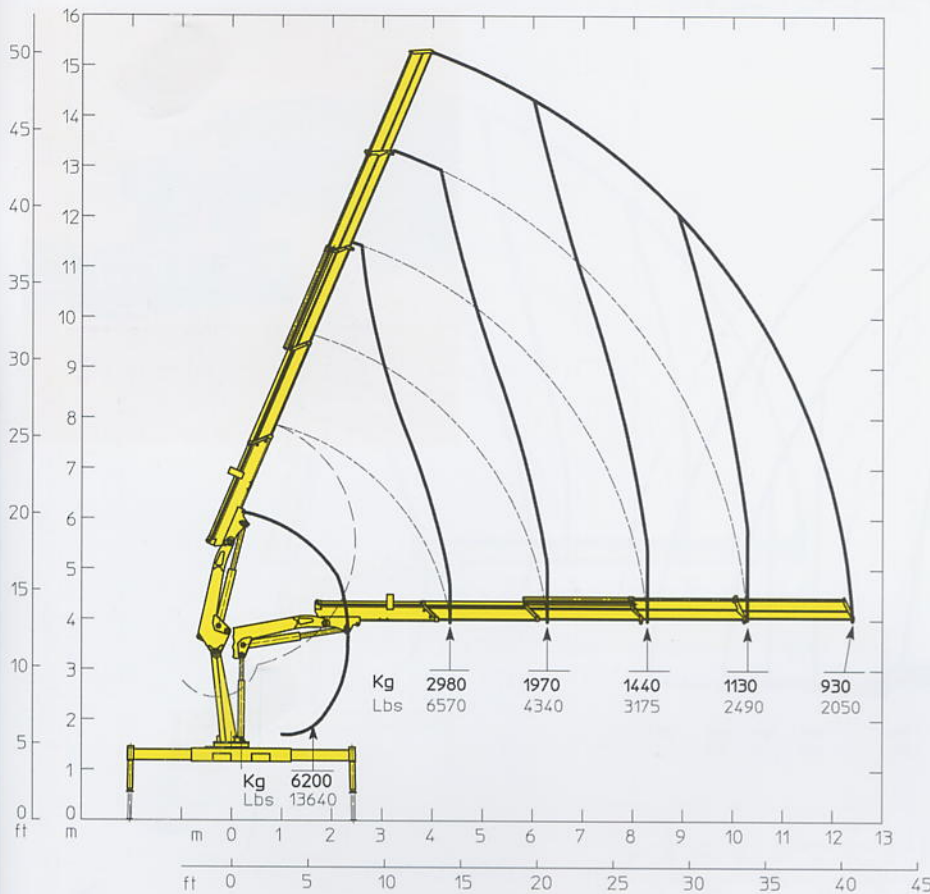

PROLUNGHE  
MANUALI

MANUAL  
EXTENSIONS

RALLONGES  
MANUELLES

MANUELLE  
VERLAENGERUNGEN

PROLONGAS  
MECANICAS

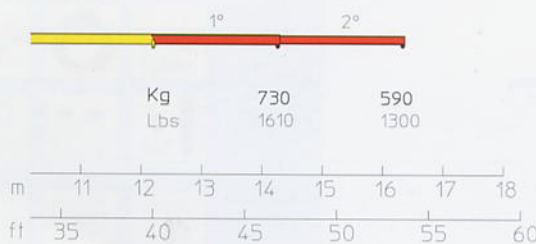

### STANDARD



### OPTIONAL

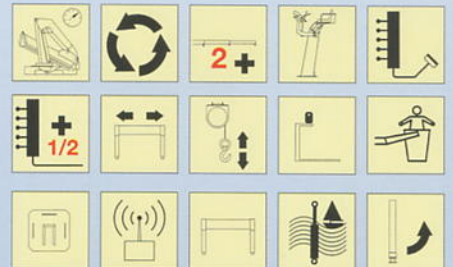

	E4	E4
Momento statico massimo al perno torretta - Max. static moment at the turret pin - Moment statique max. à l'axe de la tourelle - Max. statisches Hubmoment am Kransaulenbolzen	16600 daN • m	120090 lbs • ft
Sbraccio idraulico - Hyd. boom length - Longueur du bras Hyd. - Hyd. Reichweite	12,23 m	40'1"
Sbraccio con prolunghe manuali - Boom length with manual extensions - Longueur du bras avec rallonges manuelles - Auslegerlänge - Longitud del brazo hidráulico con prolongas manuales	16,36 m	53' 8"
Coppia di rotazione - Slew torque - Moment de rotation - Drehmoment	1750 daN • m	12660 lbs • ft
Tempo di rotazione - Slewing speed - Temp de rotation - Schwenkgeschwindigkeit	24 sec - 360°	24 sec - 360°
Uscita stabilizzatori - Outriggers extension - Sortie des bequilles - Breite der Abstützung	1610-1350 mm	5'3"-4'5"
Larghezza stabilizzatori - Outriggers width - Largeur des bequilles - Gesamtbreite der Abstützung	5325 mm	17'6"
Lunghezza - Outriggers - Largeur - Gesamtbreite - Ancho	790 mm	27"
Larghezza - Width - Largeur - Breite	2478 mm	8'2"
Altezza - Height - Hauteur - Höhe	2309 mm	7'7"
Peso (senza olio e montaggio) - Weight (without oil and fitting) - Poids (sans huile et montage) - Gewicht (ohne Öl und ohne)	2320 Kg	5115 Lbs
Portata pompa - Pump delivery - Capacité de la pompe - Pumpenleistung	35 lit / min	9 us gal/min
Pressione - Pressure - Pression - Druck	270 bar	3839 psi
Capacità serbatoio olio - Oil tank capacity - Capacité du réservoir d'huile - Öl tank inhalt - Aceite	120 lt	32 us gal



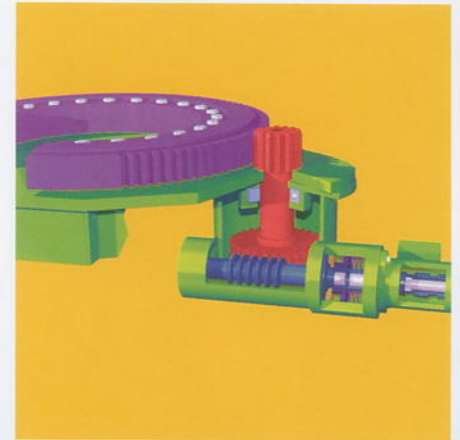
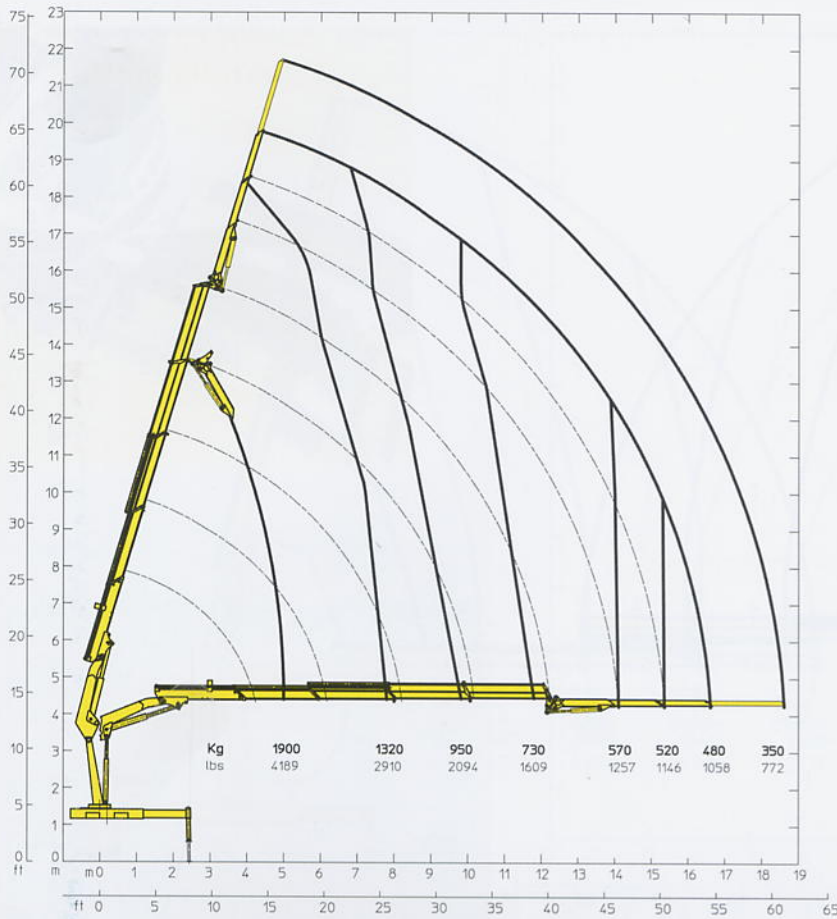

**PROLUNGHE MANUALI**      **MANUAL EXTENSIONS**      **RALLONGES MANUELLES**      **MANUELLE VERLÄNGERUNGEN**      **PROLONGAS MECANICAS**



	Kg	1450	800	500	350
Lbs	3197	1764	1102	772	

### STANDARD



### OPTIONAL

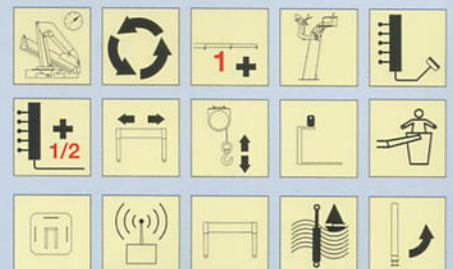

	EF	EF
Momento statico massimo al perno torretta - Max. static moment at the turret pin - Moment statique max. à l'axe de la tourelle - Max. statisches Hubmoment am Kransaulenbolzen	16600 daN • m	120090 lbs • ft
Sbraccio idraulico - Hyd. boom length - Longueur du bras Hyd. - Hyd. Reichweite	16,60 m	54'6"
Sbraccio con prolunghe manuali - Boom length with manual extensions - Longueur du bras avec rallonges manuelles - Auslegerlänge - Longitud del brazo hidráulico con prolongas manuales	18,60	61'00"
Coppia di rotazione - Slew torque - Moment de rotation - Drehmoment	1750 daN • m	12660 lbs • ft
Tempo di rotazione - Slewing speed - Temp de rotation - Schwenkgeschwindigkeit	24 sec - 360°	24 sec - 360°
Uscita stabilizzatori - Outriggers extension - Sortie des bequilles - Breite der Abstützung	1610+1350 mm	5'3"+4'5"
Larghezza stabilizzatori - Outriggers width - Largeur des bequilles - Gesamtbreite der Abstützung	5325 mm	17'6"
Lunghezza - Outriggers - Largeur - Gesamtbreite - Ancho	790 mm	27"
Larghezza - Width - Largeur - Breite	2478 mm	8'2"
Altezza - Height - Hauteur - Höhe	2309 mm	7'7"
Peso (senza olio e montaggio) - Weight (without oil and fitting) - Poids (sans huile et montage) - Gewicht (ohne Öl und ohne)	2630 Kg	5798 Lbs
Portata pompa - Pump delivery - Capacité de la pompe - Pumpenleistung	35 lit/min	9 us gal/min
Pressione - Pressure - Pression - Druck	270 bar	3839 psi
Capacità serbatoio olio - Oil tank capacity - Capacité du réservoir d'huile - Öl tank inhalt - Aceite	120 lit	32 us gal



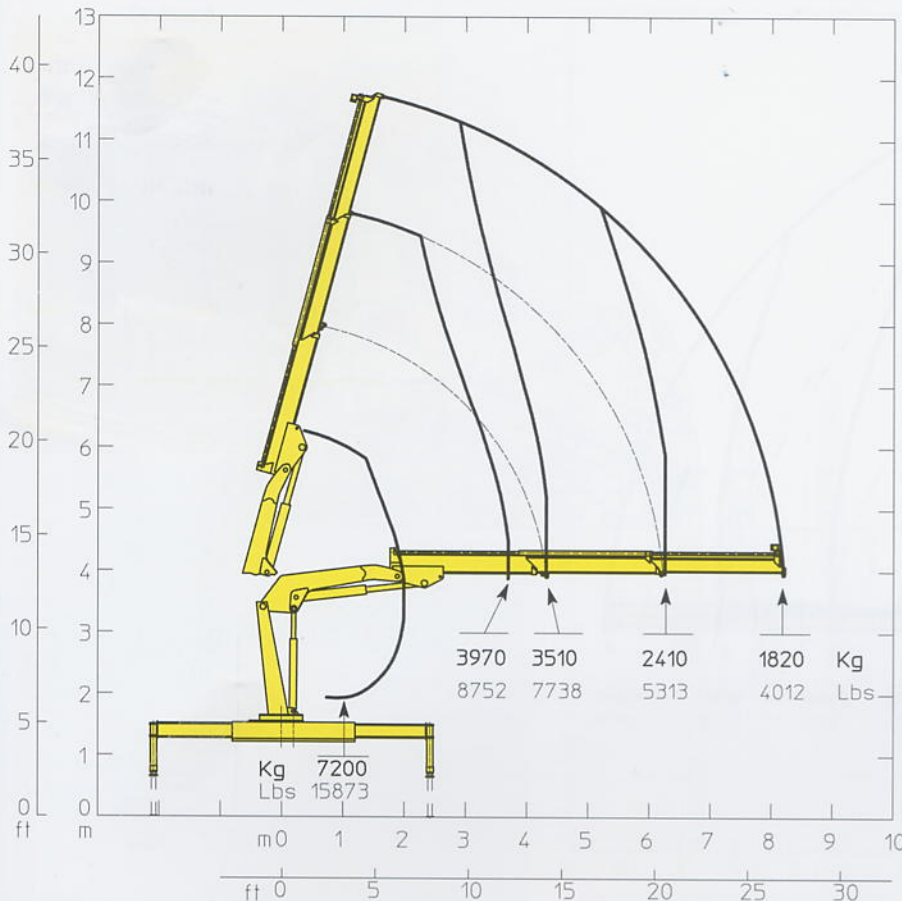

PROLUNGHE MANUALI    MANUAL EXTENSIONS    RALLONGES MANUELLES    MANUELLE VERLÄNGERUNGEN    PROLONGAS MECANICAS

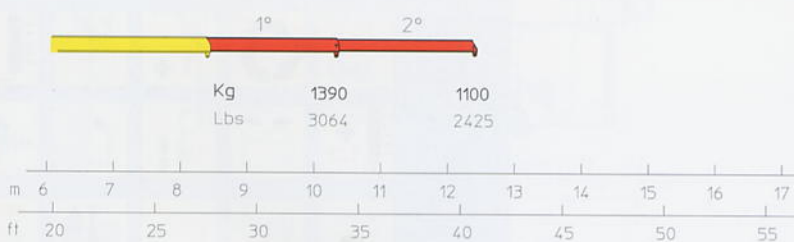

### STANDARD



### OPTIONAL

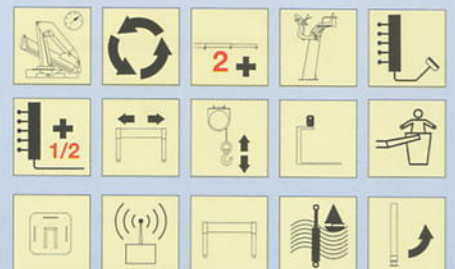

	E2	E2
Momento statico massimo al perno torretta - Max. static moment at the turret pin - Moment statique max. à l'axe de la tourelle - Max. statisches Hubmoment am Krausaulenbolzen	18000 daN • m	130219 lbs • ft
Sbraccio idraulico - Hyd. boom length - Longueur du bras Hyd. - Hyd. Reichweite	8,23 m	27'00"
Sbraccio con prolunghe manuali - Boom length with manual extensions - Longueur du bras avec rallonges manuelles - Auslegerlänge - Longitud del brazo hidráulico con prolongas manuales	16,47	54'00"
Coppia di rotazione - Slew torque - Moment de rotation - Drehmoment	1750 daN • m	12660 lbs • ft
Tempo di rotazione - Slewing speed - Temp de rotation - Schwenkgeschwindigkeit	24 sec - 360°	24 sec - 360°
Uscita stabilizzatori - Outriggers extension - Sortie des bequilles - Breite der Abstützung	1610+1350 mm	5'3"+4'5"
Larghezza stabilizzatori - Outriggers width - Largeur des bequilles - Gesamtbreite der Abstützung	5325 mm	17'6"
Lunghezza - Outriggers - Largeur - Gesamtbreite - Ancho	790 mm	27"
Larghezza - Width - Largeur - Breite	2478 mm	8'2"
Altezza - Height - Hauteur - Höhe	2309 mm	7'7"
Peso (senza olio e montaggio) - Weight (without oil and fitting) - Poids (sans huile et montage) - Gewicht (ohne Öl und ohne)	2000 Kg	4409 Lbs
Portata pompa - Pump delivery - Capacité de la pompe - Pumpenleistung	35 lit/min	9 us gal/min
Pressione - Pressure - Pression - Druck	270 bar	3839 psi
Capacità serbatoio olio - Oil tank capacity - Capacité du réservoir d'huile - Öl tank inhalt - Aceite	120 lit	32 us gal



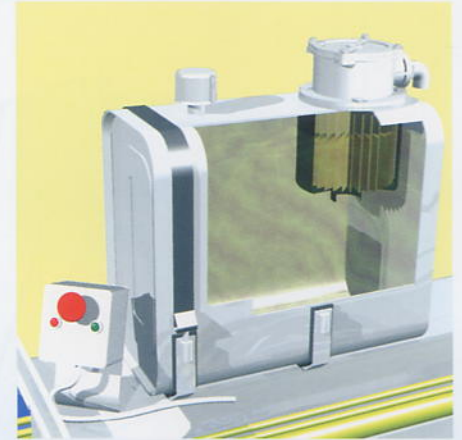
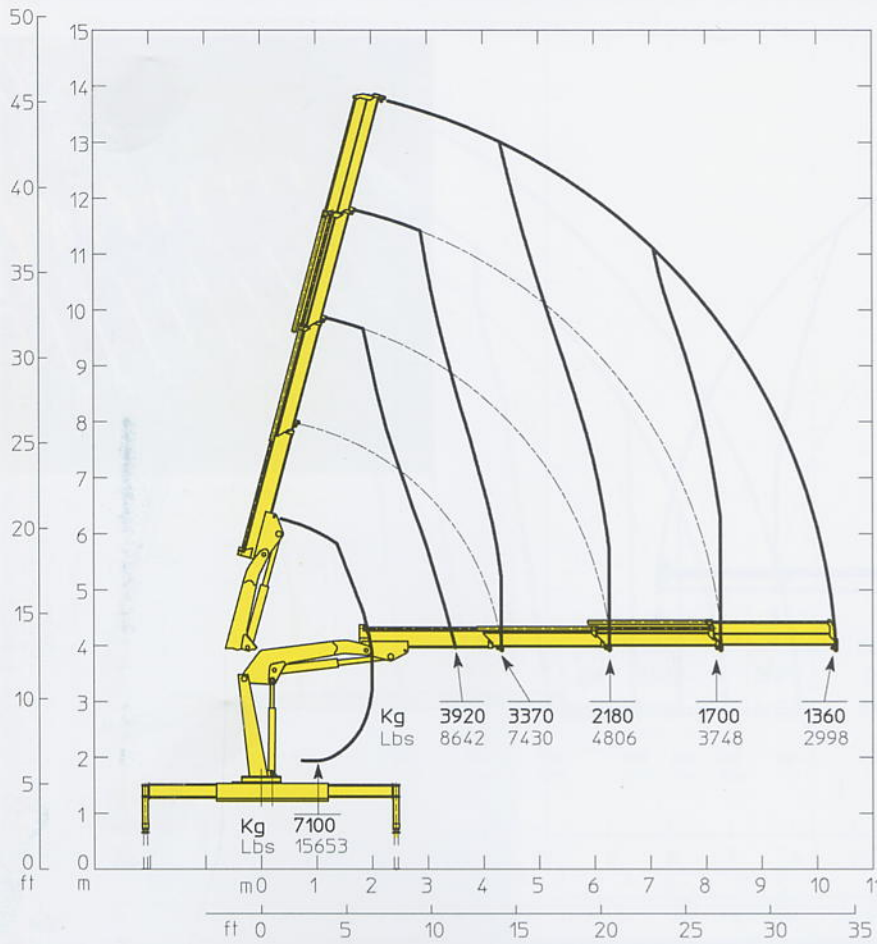

PROLUNGHE  
MANUALI

MANUAL  
EXTENSIONS

RALLONGES  
MANUELLES

MANUELLE  
VERLÄNGERUNGEN

PROLONGAS  
MECANICAS

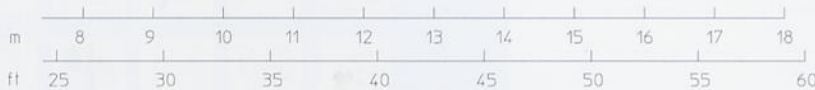
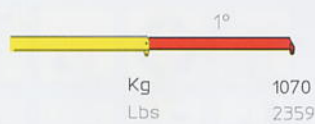

### STANDARD



### OPTIONAL

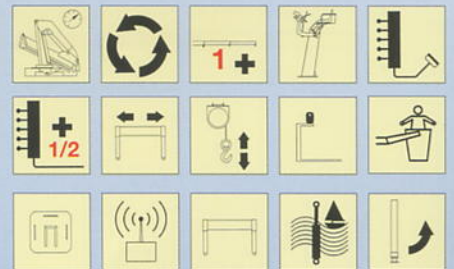

	E3	E3
Momento statico massimo al perno torretta - Max. static moment at the turret pin - Moment statique max. à l'axe de la tourelle - Max. statisches Hubmoment am Kransaulenbolzen	18000+ daN • m	130219 lbs • ft
Sbraccio idraulico - Hyd. boom length - Longueur du bras Hyd. - Hyd. Reichweite	10,27 m	33'8"
Sbraccio con prolunghe manuali - Boom length with manual extensions - Longueur du bras avec rallonges manuelles - Auslegerlänge - Longitud del brazo hidráulico con prolongas manuales	16,47 m	54' 00"
Coppia di rotazione - Slew torque - Moment de rotation - Drehmoment	1750 daN • m	12660 lbs • ft
Tempo di rotazione - Slewing speed - Temp de rotation - Schwenkgeschwindigkeit	24 sec - 360°	24 sec - 360°
Uscita stabilizzatori - Outriggers extension - Sortie des bequilles - Breite der Abstützung	1610+1350 mm	5'3"+4'5"
Larghezza stabilizzatori - Outriggers width - Largeur des bequilles - Gesamtbreite der Abstützung	5325 mm	17'6"
Lunghezza - Outriggers - Largeur - Gesamtbreite - Ancho	790 mm	27"
Larghezza - Width - Largeur - Breite	2478 mm	8'2"
Altezza - Height - Hauteur - Höhe	2309 mm	77"
Peso (senza olio e montaggio) - Weight (without oil and fitting) - Poids (sans huile et montage) - Gewicht (ohne Öl und ohne)	2150 Kg	4740 Lbs
Portata pompa - Pump delivery - Capacité de la pompe - Pumpenleistung	35 lit /min	9 us gal/min
Pressione - Pressure - Pression - Druck	270 bar	3839 psi
Capacità serbatoio olio - Oil tank capacity - Capacité du réservoir d'huile - Öl tank inhalt - Aceite	120 lt	32 us gal



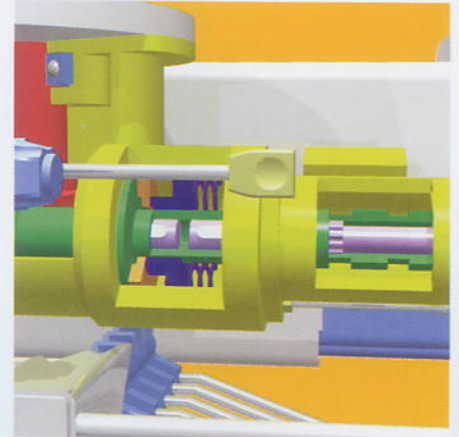
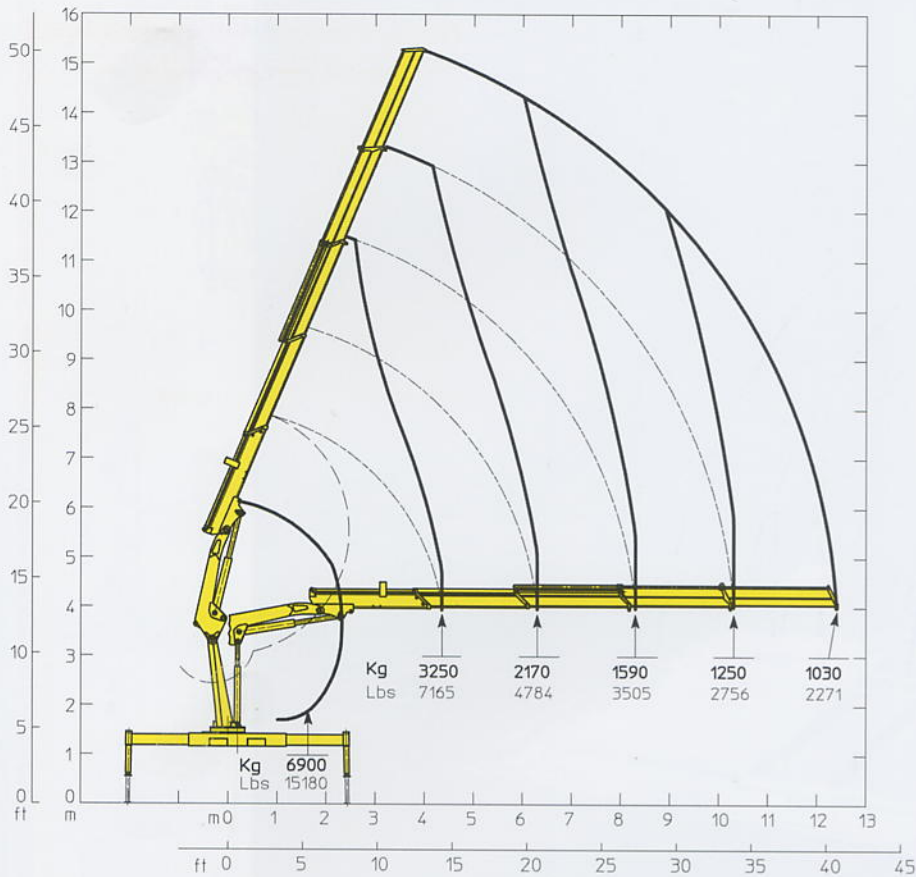

PROLUNGHE  
MANUALI

MANUAL  
EXTENSIONS

RALLONGES  
MANUELLES

MANUELLE  
VERLAENGERUNGEN

PROLONGAS  
MECANICAS

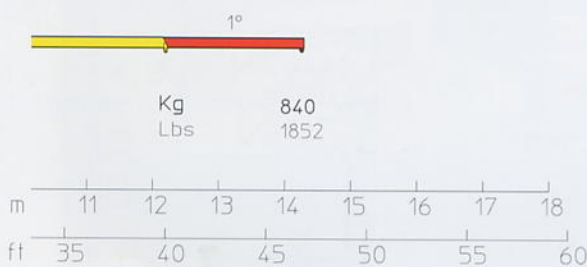

### STANDARD



### OPTIONAL

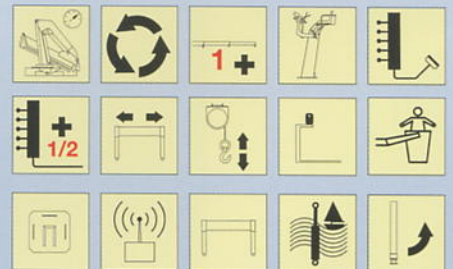

	E4	E4
Momento statico massimo al perno torretta - Max. static moment at the turret pin - Moment statique max. à l'axe de la tourelle - Max. statisches Hubmoment am Kransaulenbolzen	18000 daN • m	130219 lbs • ft
Sbraccio idraulico - Hyd. boom length - Longueur du bras Hyd. - Hyd. Reichweite	12,23 m	40'1"
Sbraccio con prolunghe manuali - Boom length with manual extensions - Longueur du bras avec rallonges manuelles - Auslegerlänge - Longitud del brazo hidráulico con prolongas manuales	16,36	53'8"
Coppia di rotazione - Slew torque - Moment de rotation - Drehmoment	1750 daN • m	12660 lbs • ft
Tempo di rotazione - Slewing speed - Temp de rotation - Schwenkgeschwindigkeit	24 sec - 360°	24 sec - 360°
Uscita stabilizzatori - Outriggers extension - Sortie des bequilles - Breite der Abstützung	1610+1350 mm	5'3"+4'5"
Larghezza stabilizzatori - Outriggers width - Largeur des bequilles - Gesamtbreite der Abstützung	5325 mm	17'6"
Lunghezza - Outriggers - Largeur - Gesamtbreite - Ancho	790 mm	27"
Larghezza - Width - Largeur - Breite	2478 mm	8'2"
Altezza - Height - Hauteur - Höhe	2309 mm	7'7"
Peso (senza olio e montaggio) - Weight (without oil and fitting) - Poids (sans huile et montage) - Gewicht (ohne Öl und ohne)	2320 Kg	5119 Lbs
Portata pompa - Pump delivery - Capacité de la pompe - Pumpenleistung	35 lit /min	9 us gal/min
Pressione - Pressure - Pression - Druck	270 bar	3839 psi
Capacità serbatoio olio - Oil tank capacity - Capacité du réservoir d'huile - Öl tank inhalt - Aceite	120 lit	32 us gal



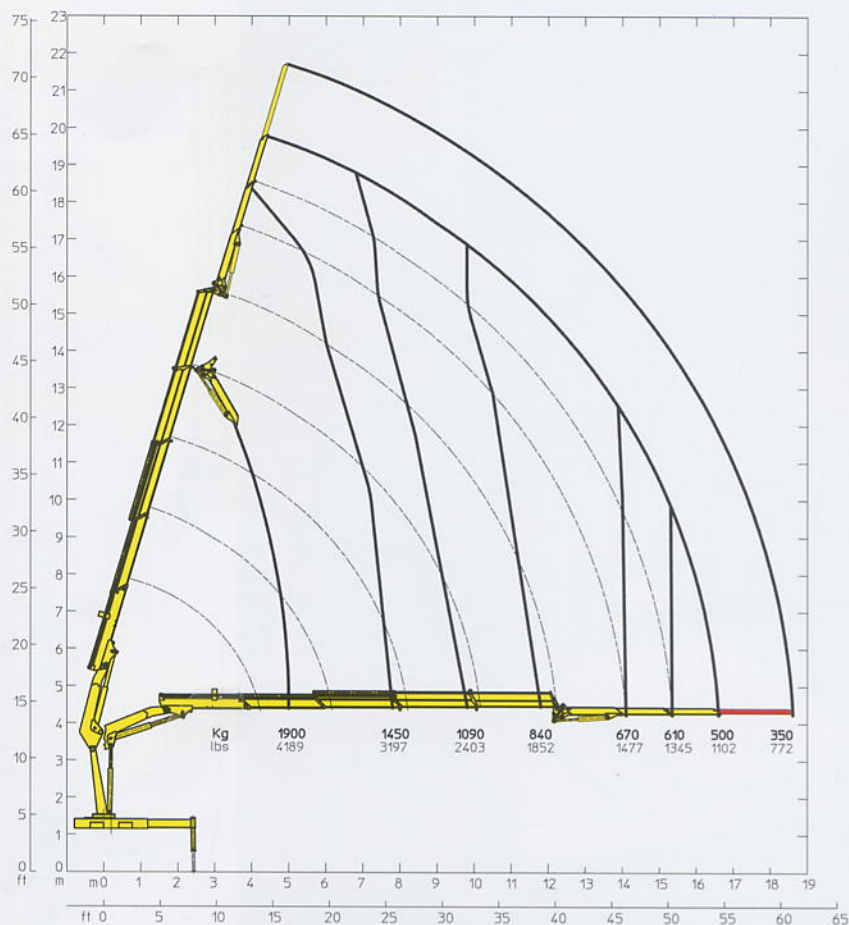

PROLUNGHE  
MANUALI

MANUAL  
EXTENSIONS

RALLONGES  
MANUELLES

MANUELLE  
VERLÄNGERUNGEN

PROLONGAS  
MECANICAS



	1450	800	500	350
Kg	1450	800	500	350
Lbs	3197	1764	1102	772

### STANDARD



### OPTIONAL



Momento statico massimo al perno torretta - Max. static moment at the turret pin - Moment statique max. à l'axe de la tourelle - Max. statisches Hubmoment am Krausaulenbolzen

Sbraccio idraulico - Hyd. boom length - Longueur du bras Hyd. - Hyd. Reichweite

Sbraccio con prolunghe manuali - Boom length with manual extensions - Longueur du bras avec rallonges manuelles - Auslegerlänge - Longitud del brazo hidráulico con prolongas manuales

Coppia di rotazione - Slew torque - Moment de rotation - Drehmoment

Tempo di rotazione - Slewing speed - Temp de rotation - Schwenkgeschwindigkeit

Uscita stabilizzatori - Outriggers extension - Sortie des bequilles - Breite der Abstützung

Larghezza stabilizzatori - Outriggers width - Largeur des bequilles - Gesamtbreite der Abstützung

Lunghezza - Outriggers - Largeur - Gesamtbreite - Ancho

Larghezza - Width - Largeur - Breite

Altezza - Height - Hauteur - Höhe

Peso (senza olio e montaggio) - Weight (without oil and fitting) - Poids (sans huile et montage) - Gewicht (ohne Öl und ohne)

Portata pompa - Pump delivery - Capacité de la pompe - Pumpenleistung

Pressione - Pressure - Pression - Druck

Capacità serbatoio olio - Oil tank capacity - Capacité du réservoir d'huile - Öl tank inhalt - Aceite

EF

EF

18000+ daN • m

130219 lbs • ft

16,60 m

54'6"

18,60 m

61'00"

1750 daN • m

12660 lbs • ft

24 sec - 360°

24 sec - 360°

1610-1350 mm

5'3"-4'5"

5325 mm

17'6"

790 mm

27"

2478 mm

8'2"

2309 mm

77"

2630 Kg

5798 Lbs

35 lit/min

9 us gal/min

270 bar

3839 psi

120 lt

32 us gal



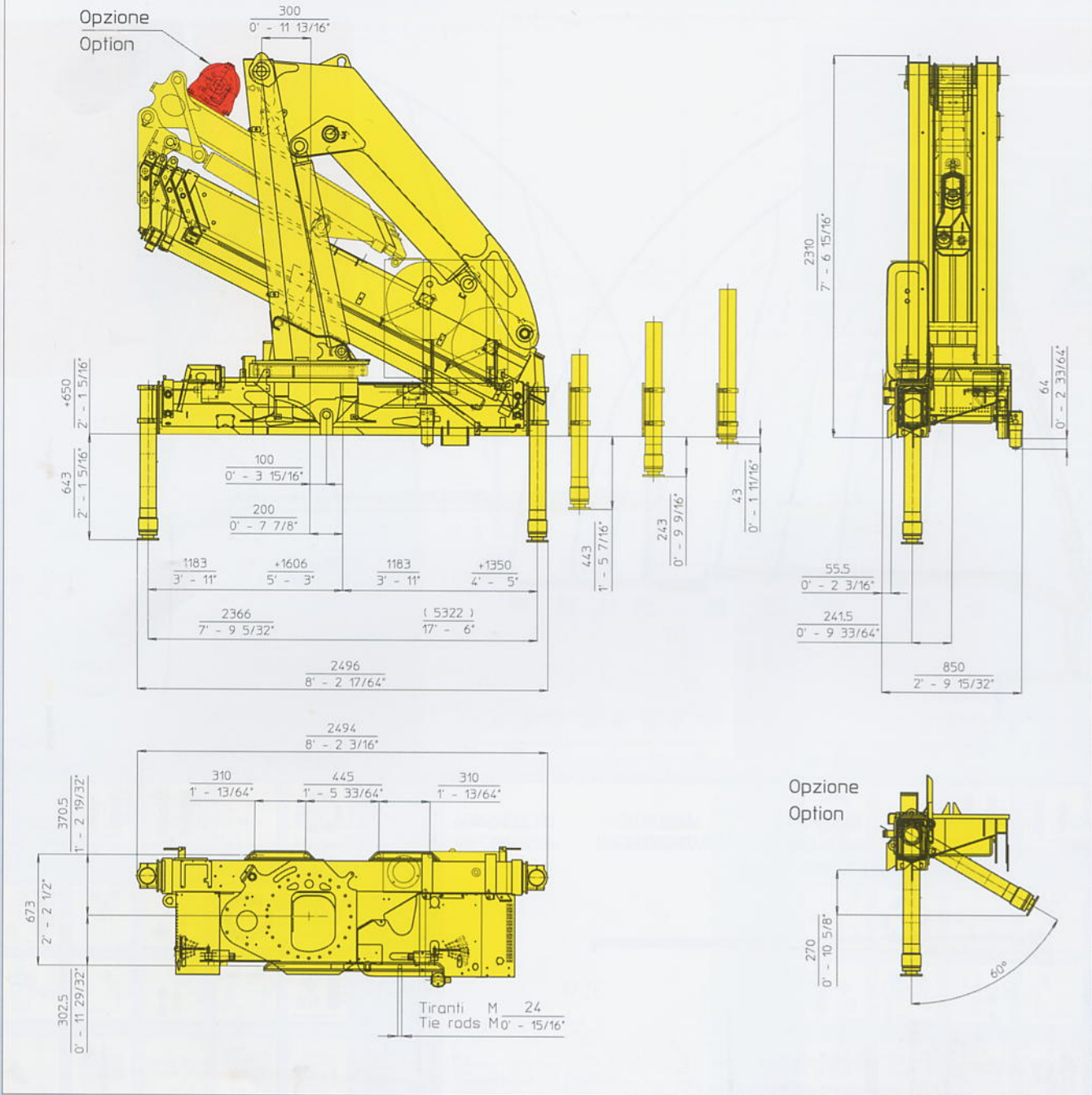

A fronte di una continua ricerca tecnologica i dati possono cambiare senza preavviso. Contattare il nostro Ufficio Commerciale per ulteriori informazioni.  
 -Because of continuous technology research data can change without notice. Please, contact our Commercial Dept. for further information.  
 -A cause de une continue recherche technologique les données peuvent changer sans préavis. Contacter notre Bureau Commercial pour des autres informations.  
 -Irrtum und technische änderung vorbehalten masse und gewichte unverbindlich. Unser Vertrieb erteilt Ihnen gerne weitere Auskünfte. Bitte rufen Sie uns an.  
 -Debido a los continuos avances tecnológicos los datos pueden variar sin notificación previa. Para más información rogamos contacten nuestro Departamento Comercial.

## STANDARD

- Comandi bilaterali  
Dual control stations  
Commandes à gauche et à droite  
Beidseitige Bedienung  
Mandos bilaterales
- Limitatore di momento  
Load limiting device  
Limiteur de charge  
Überlastabschaltung  
Limitador de momento (de carga)
- Comando supplementare non attivato  
Additional free section not activated  
Section du distributeur pas activée  
Zusätzlicher steuerschieber  
Mando auxiliar no activado
- Rotazione 360°  
Rotation 360°  
Rotation 360°  
Drehbereich 360°  
Rotación 360°

## OPTIONAL

- Rotazione continua  
Continuous rotation  
Rotation continue  
Endlos Schwenkwerk  
Rotación continua
- Comando supplementare attivato  
Additional function  
Section du distributeur activée  
Zusatzfunktion  
Mando auxiliar activado
- Verricello  
Winch  
Treuil  
Seilwinde  
Cabrestante
- Trattamento marino della gru  
Marine treatment of the crane  
Traitement marin de la grue  
Marine behandlung des Krans  
Tratamiento especial marino de la grua
- Radiocomando  
Radio remote control  
Radiocommandes  
Funkfernsteuerung  
Radiomando
- Posto di manovra in alto  
Top seat  
Siege en haut  
Hochsitz  
Puesto de maniobra en alto
- Piastre maggiorate  
Large ground plates  
Plagues stabilisateurs  
Bodenplatten  
Placas estabilizadoras de suelo de gran tamaño
- Stabilizzatori gru base estendibili idraulicamente  
Outriggers with hydraulic extension  
Stabilisateurs avec extension hydraulique  
Hydraulisch Ausfahrbare stützen  
Estabilizadores grua base despiegables hidráulicamente
- Telecomando  
Cable remote control  
Telecommandes  
Kabelfernsteuerung  
Control remoto
- Traversa ausiliaria estendibile  
Additional outriggers with lateral extension  
Stabilisateurs supplémentaires avec élargissement  
Ausfahrbare Zusatz-Stützen  
Estabilizadores adicionales con extensión lateral
- Prolunghe meccaniche  
Manual extensions  
Rallonges manuelles  
Manuelle Verlängerungen  
Prolongas mecánicas
- Utilizzo con attrezzo  
Additional accessories  
Utilisation avec accessoire  
Zubehör  
Accesorios auxiliares
- Traversa ausiliaria fissa  
Additional outriggers beam without extension  
Stabilisateur supplémentaires sans élargissement  
Zusätzliche abstützbeine  
Estabilizadores suplementarios fijos
- Cestello  
Basket  
Nacelle  
Personenkorb  
Cesta





# CORMAGH

Cormach s.r.l. - Via Madonnina, 27 - C.P. 199 - 25018 MONTICHIARI (BS) - ITALY  
Tel. 0039.030.9656811 - Telefax 0039.030.9656846.7.8  
E-mail: [info@cormach.com](mailto:info@cormach.com) - Web: <http://www.cormach.com>